

Varenummer: 2310431039S  
Beskrivelse: E+G Stilleben  
LX.40-SW17-M8X72-S

## Mål

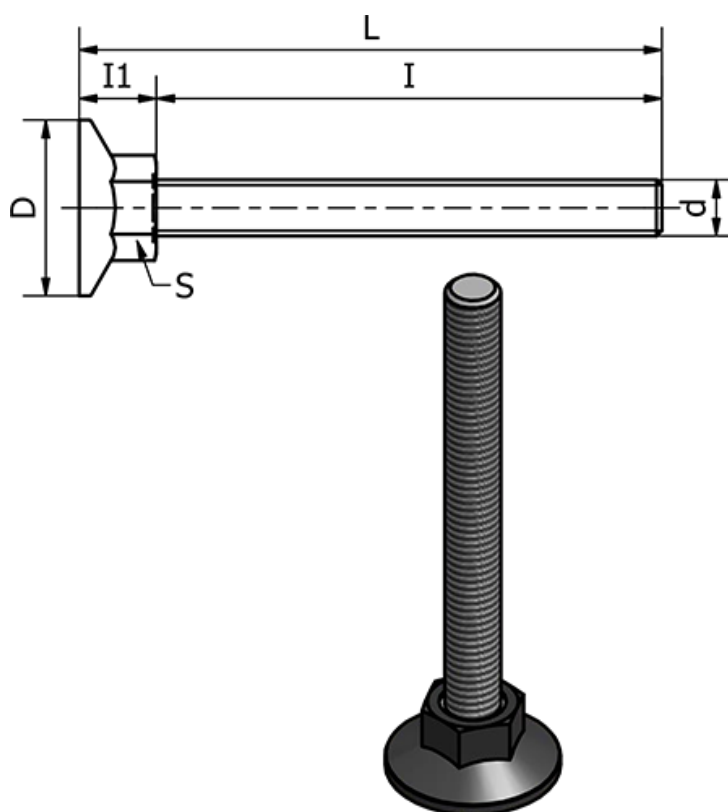

d	= M8
D	= 40
I	= 72
I1	= 13
L	= 84.5
Max statisk belastning (N)	= 2500
S	= 17
Type	= Forzinket

Vægt (g) = -